

Exit Stopper®

Quick Install

STI-6400 Series

SET UP

1. Key in OFF position

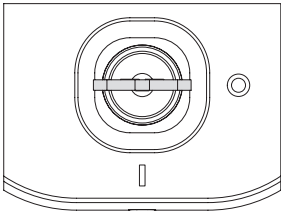

2. Remove security screw with provided wrench

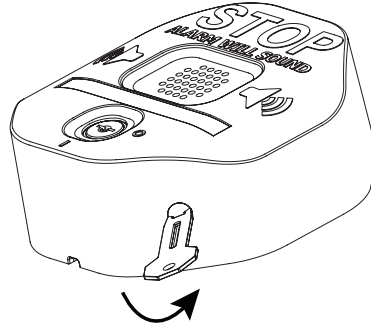

3. Remove cover from base, push on lock to separate

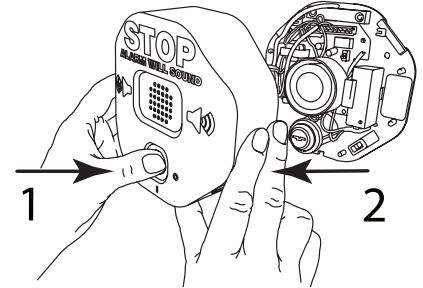

4. Choose setting – refer to switch table, default settings shown side 2

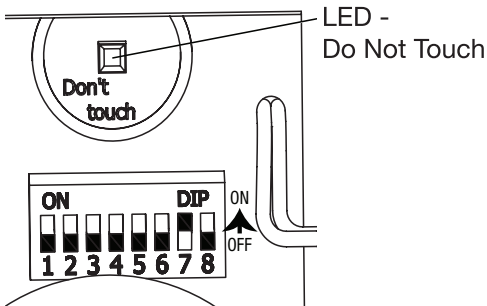

5. Unwrap battery and connect

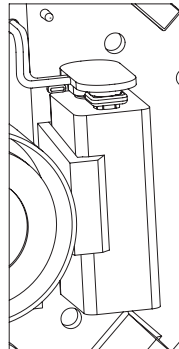

6. Terminal block (for remote and relay options) – refer to full install online for wiring connections

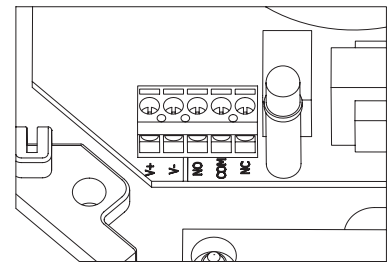

7. Test – place magnet next to reed, turn on, separate magnet from reed

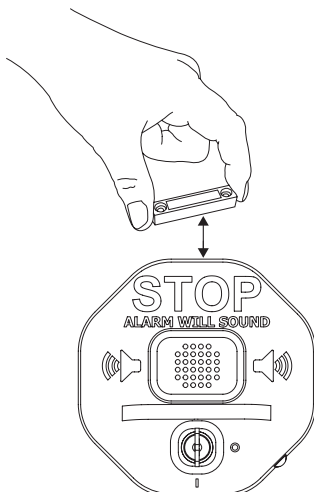

8. Apply language label if desired

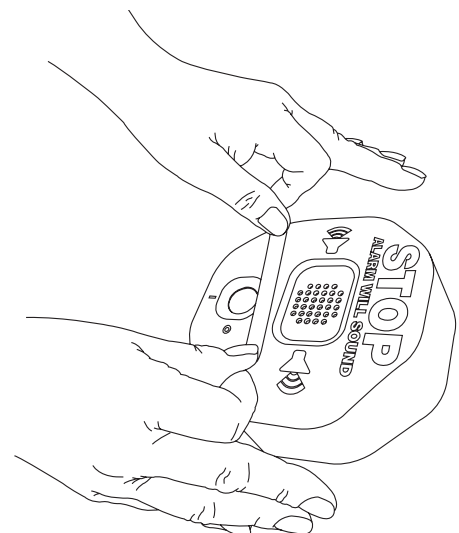

MOUNTING

9. Place reed at desired location (top, right, bottom or left)

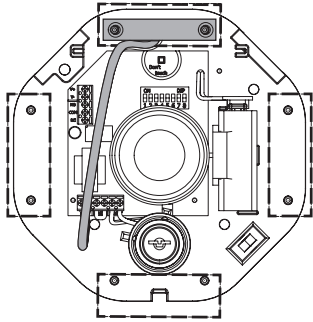

10. Position base. Mark and drill four (4) holes 1" (25mm) deep. Using plastic anchor, drill 3/16" (4.5mm). Install into wood or steel: drill 9/64" (3.5mm). Mount using (4) M4 x 25mm screws.

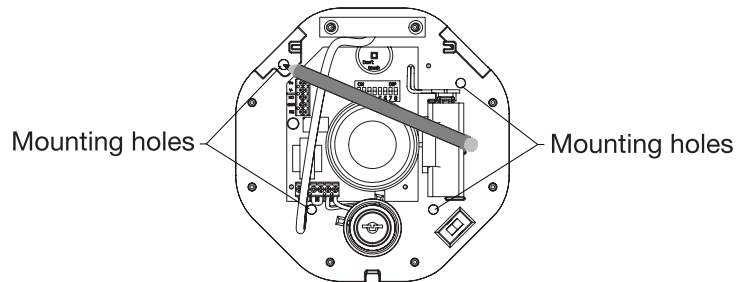

11. Install reed magnet, mark with pencil, drill, install using plastic anchor, drill 3/16" (4.5mm). Install into wood or steel: drill 1/8" (3mm). Mount with (2) M3.5 x 32mm screws.

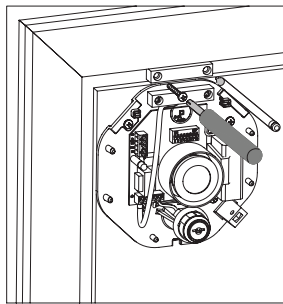

12. Test, turn key on, open door

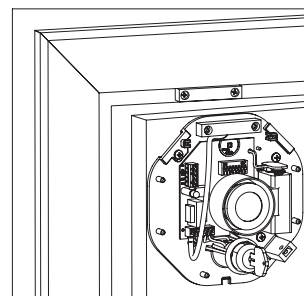

13. Replace cover, snap lid from top, secure with security screw

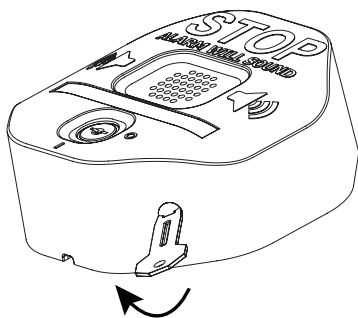

SWITCH SETTINGS	1	2	3	4	5	6	7	8
Arming - immediate	OFF*							
Arming - 15 second delay	ON							
Trip - immediate		OFF*						
Trip - 15 second delay		ON						
Shut-off based on duration (switches 4 & 5)			OFF*					
Shut-off approx. 3 sec. after door closes			ON					
Duration - 30 second alarm				OFF*	OFF*			
Duration - 180 second alarm				OFF	ON			
Duration - continuous alarm				ON	OFF			
Duration - annunciator mode				ON	ON			
Low battery detection on - Turn switch off						OFF*		
Low battery detection off - Turn switch on						ON		
Volume - high							ON*	
Volume - low							OFF	
Relay function → OFF								OFF*
Relay function → ON								ON

*default

NOTE: **Disconnect all power sources before changing switch settings.**

Warranty

Three year warranty or a one year limited warranty (from date of purchase) on most products. See website for details. Electronic warranty form at www.sti-usa.com/wc14.

⚠ WARNING: This product can expose you to chemicals including Dichloromethane, which is known to the State of California to cause cancer, and Bisphenol A (BPA), which is known to the State of California to cause birth defects or other reproductive harm. For more information go to www.P65Warnings.ca.gov.



Safety Technology International

2306 Airport Rd • Waterford, MI 48327, USA
 Phone: 248-673-9898 • Fax: 248-673-1246
info@sti-usa.com • www.sti-usa.com

Taylor House • 34 Sherwood Road • Bromsgrove, Worcestershire • B60 3DR • England
 Tel: +44 (0)1527 520 999 • Fax: +44 (0)1527 501 999 • info@sti-emea.com • www.sti-emea.com

Subject to change without notice.

6400 QUICK INSTALL
 JUNE 2019